

PLAN

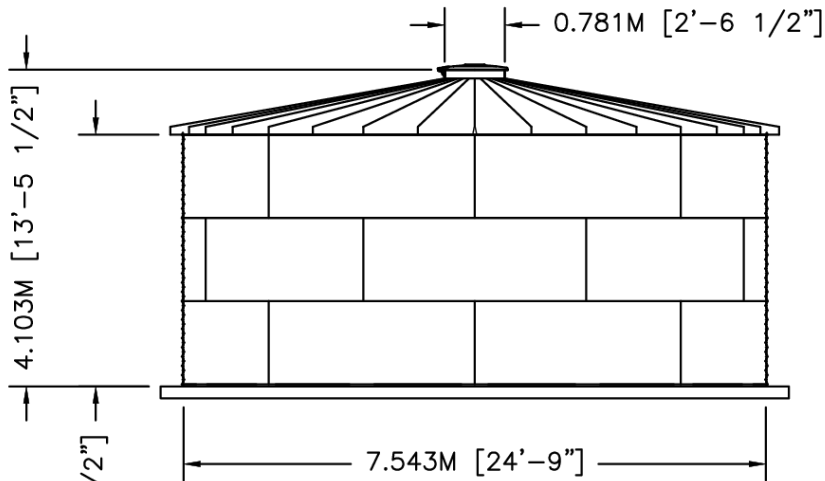

ELEVATION

		BY	DATE	TITLE		
	DWN	XXX	XX/XX/XX	WTU08-03 30"PR 10DEG V-RIB		
	CKD			NOMINAL CAPACITY - 140.193 M3 [37,035 GAL]		
	ENG			DWG. NO. SCT2403-LVR WTU08-03	REV. NO.	
				SIZE: A	SCALE: 1/8"=1'-0"	SHEET 1 OF 1